

CO2 Monitor Operating Instructions

Model: RAD-0102-6 Remote CO2 Storage Safety System

1. Product Overview

Thank you for selecting the RAD-0102-6 CO2 Storage Safety Alarm. This monitor is designed to detect Carbon Dioxide levels in the ambient air to protect employees and customers. CO2 monitors are required in most jurisdictions by code. High concentrations of CO2 in confined spaces are dangerous, and may lead to health problems ranging from headaches and fatigue to asphyxiation and death. This monitor has 3 audible and visual alarm levels with relays that are triggered at 5,000 ppm TWA, 15,000 ppm, and 30,000 ppm and can control a ventilation fan or signal the fire panel to send an alarm to the fire department or monitoring company. These standards meet IFC, NFPA, and NBIC requirements for monitoring.



RAD-0102-6 CO2 Monitor is cost-effective and includes these features:

- 1.) Multiple RDU's can be connected for additional alarm points.
- 2.) Large digital LCD display clearly indicates the ambient CO2 concentration, relative humidity, and temperature.
- 3.) 3 independent relay outputs can automatically control vent fan or be wired to the fire alarm panel.
- 4.) Audible and visual alarm indications.
- 5.) Automatic altitude compensation (can be turned on/off).
- 6.) 4-20 mA output for offsite monitoring.
- 7.) 100% clean look by burying all cables in the wall.
- 8.) Allows for field upgrades with strobe package at a later date.

2. Package Content & Unit Layout

The RAD-0102-6 package comprises the following parts:

- SEU (Main Unit),
- RDU (Remote Unit)
- CAT 5 Communication Cable (1 piece)
- Relay Cables (3 pieces)
- Wall Plug Safety Strap (1 piece)
- Mounting Brackets (2 pieces)
- Screws (13 pieces), Wall Anchors (12 pieces), Cable Clips (10 pieces)
- Power Supply (1 Piece), International Power Adaptors (3 pieces)
- Warning Signs (6 pieces)
- User Manual (1 piece).

SEU (Main Sensor Unit)

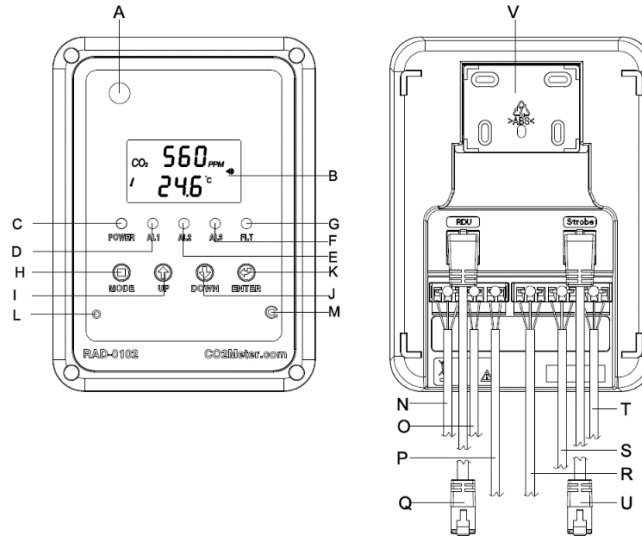

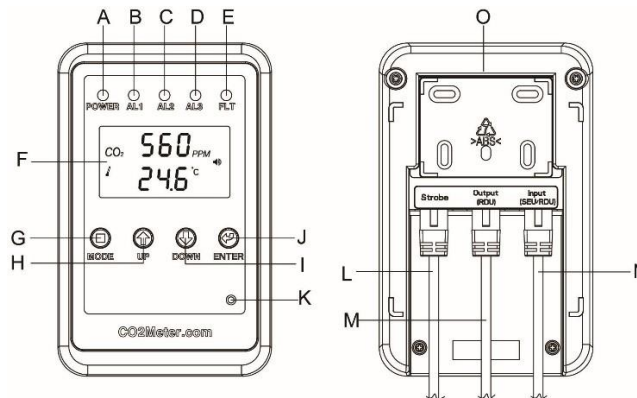

- | | | |
|------------------------------|----------------------------|-------------------------------|
| A. CO2 Sensor | B. LCD display | C. Power (Green LED) |
| D. AL1 (Red 1 LED) | E. AL2 (Red 2 LED) | F. AL3 (Red 3 LED) |
| G. Fault (Yellow LED) | H. Mode Button | I. UP Button |
| J. Down Button | K. Enter Button | L. Buzzer |
| M. Reset Button | N. 4-20mA Output | O. Battery |
| P. DC Power Supply | Q. RDU Cable (RJ45) | R. Relay 3 (AL3) |
| S. Relay 2 (AL2) | T. Relay 1 (AL1) | U. Strobe Cable (RJ45) |
| V. Panel Holder | | |

RDU (Remote Display Unit)



- | | | |
|--------------------------------------|---|-------------------------------|
| A. Power (Green LED) | B. AL1 (Red 1 LED) | C. AL2 (Red 2 LED) |
| D. AL3 (Red 3 LED) | E. Fault (Yellow LED) | F. LCD display |
| G. Mode Button | H. UP Button | I. Down Button |
| J. Enter Button | K. Buzzer | L. Strobe Cable (RJ45) |
| M. Output Cable to RDU (RJ45) | N. Input Cable from SEU/RDU (RJ45) | O. Panel Holder |

3. LCD Display Symbol

Symbol	Meaning	Description
	CO2 Concentration ppm (Parts Per Million)	Ambient CO2 Concentration
	Alarm	Alarm Icon
DIAG	Diagnose	Test communications between the SEU and RDU (see 9.1)
AL1	CO2 5,000 TWA	Relay 1 will trigger when CO2 concentration exceeds 5000ppm TWA (Time Weighted Average). The AL1 (Red 1 LED) will flash but buzzer will not sound. (see 9.2)
AL2	2 nd CO2 Alarm Level	Relay 2 will trigger when CO2 concentration exceeds the 2nd alarm level. (Preset at 15,000ppm). The AL2 (Red 2 LED) will flash. The buzzer will sound. (see 9.3)
AL3	3 rd CO2 Alarm Level	Relay 3 will be triggered when CO2 concentration exceeds the 3rd alarm level. (Preset at 30,000ppm) The AL2 (Red 2 LED), AL3 (Red3 LED), and Fault LED will flash. The buzzer will sound. This status will be latched. (see 9.4)
CALI	Calibration	To calibrate the CO2 sensor when the accuracy deviates from the actual CO2 concentration. (see 9.5)
RCFS	Recover Factory Setting	To recover factory default settings and remove any customized settings. (See 9.6)
Hi	High	CO2 concentration is above 5% (50,000 ppm)
	Fan Icon	CO2 levels exceeds Alarm2, the fan icon will appear. If connected via Relay 2, this would turn on a ventilation fan.

4. SEU (Main Sensor Unit)

The SEU (Main Sensor Unit) should be placed in a room where CO₂ is likely to accumulate, a room where CO₂ is stored, like an area with CO₂ beverages.

The large LCD displays the ambient CO₂ concentration.

The SEU has “DIAG”, “AL1”, “AL2”, “AL3”, “CO₂ CALI”, “RCFS” functions:

“DIAG” function executes communication tests between the SEU and RDU.

“AL1” is a fixed 5000ppm TWA.

“AL2” and “AL3” are two CO₂ alarm levels. These alarm levels are adjustable.

- AL2 has CO₂ level of: 5000, 1.0%, 1.5%, 2.0%, 2.5%, 3.0%. (AL2 default is 1.5%)
- AL3 has CO₂ levels of: 2.0%, 2.5%, 3.0%, 3.5%, 4.0%. (AL3 default is 3.0%)

“CALI” function allows the user to perform calibration, when necessary.

“RCFS” function allows the user to re-set the unit to the original factory settings.

When the RAD-0102-6 detects a CO₂ TWA (average in 8 hours) value that exceeds 5,000ppm, the AL1 (Red 1 LED) will blink and Relay 1 will be triggered.

When the CO₂ TWA value drops below 5000ppm (with 5% hysteresis), AL1 (Red1 LED) will stop blinking and Relay 1 will be inactive.

When the RAD-0102-6 detects a CO₂ value that exceeds the AL2 CO₂ level, AL2 (Red 2 LED) will blink, the buzzer will sound and Relay 2 will be triggered.

When the CO₂ value drops below the AL2 CO₂ level, AL2 (Red 2 LED) will stop blinking, the buzzer will stop and Relay 2 will be inactive.

If the CO₂ concentration continues to rise and exceeds the AL3 CO₂ level, AL2 (Red 2 LED) and AL3 (Red 3 LED) will flash together. The tempo of the flashing and buzzer will increase. RAD-0102-6 will latch after this event. When the CO₂ value drops below the AL3 CO₂ level and then below the AL2 CO₂ level, the flashing and buzzer will stop, but the Fault LED will remain flashing. The RAD-0102-6 must be reset, by means of reset button of RAD-0102-6 (see item L in Section 2 SEU layout) or power cycle the unit.

The Power (Green LED) will light continuously when the power is normally supplied. If the device is powered by a battery, the Power (Green LED) will flash and battery indicator will appear and change with the battery voltage.

If the communication cable between the SEU & RDU is not connect well, the communication cable is loose or disconnected from the (RJ45) connectors, the fault LED of SEU will blink as a reminder for the user to reconnect the cable. If the communication cable is inserted into the wrong port on RDU, after about one minute, the “Er7” will flash on the RDU LCD. Please plug the cables into the correct ports on RDU and the unit will work normally.

5. RDU (Remote Display Unit)

The RDU displays the data from the SEU and provides visual and audible indication that the SEU is in alarm status. The RDU is NOT an external/second sensor. The RDU is connected to the SEU with a CAT5 cable. A 25-foot CAT5 cable is provided. Users can source additional cable lengths as needed. The RDU should be placed where it can be conveniently observed (eye level) before entering the room/space.

The “DIAG” function can test the communication between the SEU and RDU (see 9.1). Resetting the RAD-0102-6 CO2 Monitor is only available from SEU.

6. Strobes

The RAD-0102-6 can be equipped with strobes for additional visual alarms. Using CAT5 cables, connect the strobes to the correct RJ45 ports on the SEU and RDU. If CO2 levels exceed AL2, the strobe will flash. If the CO2 level exceeds AL3, the strobe tempo increases.

Please visit www.CO2Meter.com for strobe package. Part Number: CM-1026.

7. Power

The RAD-1020-6 comes pre-wired with a 12V power supply that plugs in to a wall outlet. The 12V power supply can be removed and 24V DC can be wired directly to the device through the terminal block. Please use a 24V DC power converter to properly convert your AC power source.

8. Installation Instructions

Please carefully remove all items from the package and follow the Step-by-Step Installation Instructions:

1. Choose a suitable location to install the SEU. Fix the panel holder on the wall with the four screws. Install the SEU 18 inches from floor and close to the CO2 source.
2. Put the SEU on the panel holder, making sure that they are connected tightly.
3. Fix another panel holder in a suitable location outside the monitored space at eye level. Place the RDU onto panel holder, and stick the warning signs next to RDU.
4. Route the 25-foot CAT5 cable between the SEU and RDU. CAT5 cable can be run through the wall/conduit or fixed to the wall using cable clips. Plug the CAT5 cable into the designated ports. Communication between the SEU and RDU is complete.
5. The RAD-0102-6 has 3 relay outputs connected to the programmed alarm settings. All relays are normally open/closed dry contacts. Any of the relays can be used to control an external device (fan, HVAC system, etc.) or can be wired to the fire alarm panel directly. The relays will trigger when the CO2 concentration exceeds the programmed alarm level.
6. When the power has been connected, The SEU and the RDU will begin to work.
7. Please use the “DIAG” function to verify the communication between SEU and RDU, the five LED’s will blink and buzzer will sound on SEU & RDU, after that the communication is ready. The units will display the same information.

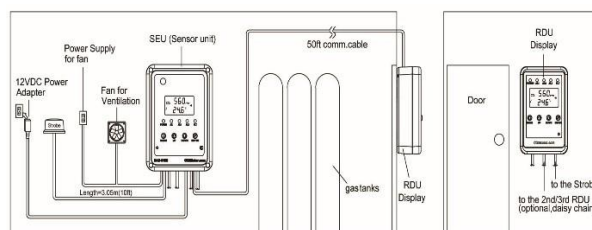

9. Advanced Management Settings

9.1) Latch function: On/Off. Default is On.

Fault light will keep flashing if AL3 is activated, indicating unit went into alarm status.

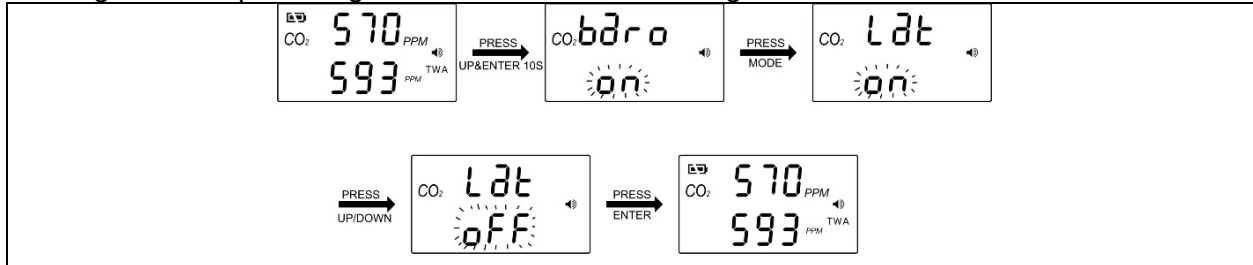

1. Press Up & Enter button for 10 seconds
2. Change to Advance Mode by pressing Mode, and choose Lat Mode
3. Press Up/Down to set Latch Mode On or Off.
4. Press Enter to Save

9.2) Alarm Level Lock: Lock/Unlock.

User cannot adjust the alarm levels when Locked. Default is Lock.

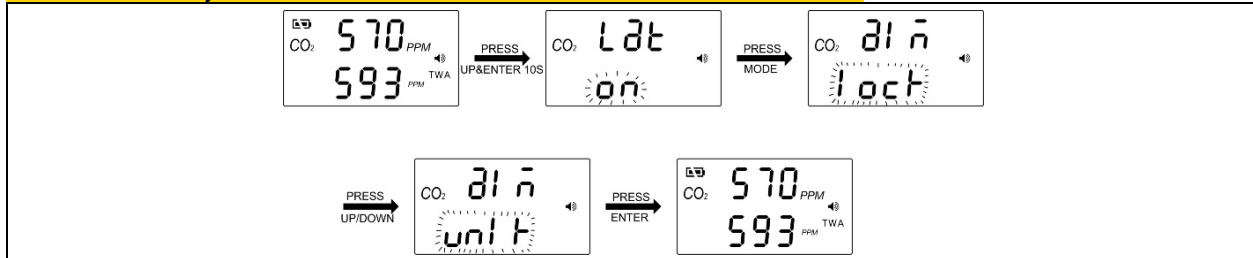

1. Press Up & Enter button for 10 seconds
2. Change to Advance Mode by press Mode, and choose Alm Mode
3. Press Up/Down to set Alm level Lock or Unlk.
4. Press Enter to Save.

9.3) Barometric compensation: On/Off. Default is On.

Unit automatically compensates for barometric pressure / altitude.

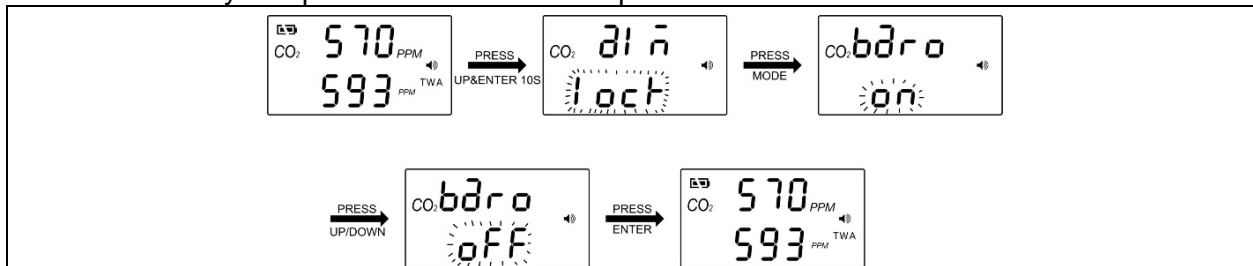

1. Press Up & Enter button for 10 seconds
- 2 Change to Advance Mode by press Mode, and choose Baro Mode
3. Press Up/Down to set Baro Mode On or Off.
4. Press Enter to Save.

10. Customizing the Settings

When power has been connected, all LEDs will flash and buzzer will beep 4 times, at this time, the LCD will show all icons for about 4 seconds.

After that, the SEU and RDU will begin to monitor the CO₂ concentration.

In order to get timely alarm safety information and meet the personal requirements, it is advisable to set up the customizing parameter.

Select Temperature Unit °C/°F: Press “Up” to switch between °C and °F



Select Barometric hPa/inHg: Press “Down” to switch between hPa and inHg



10.1) Using the DIAG function: Will test the communication link from SEU & RDU.

1. Press Mode until the “DIAG” icon flashes		
2. Press Enter, the SEU’s five LEDs will blink and the buzzer will sound		
3. The RDU’s five LEDs will blink and buzzer will sound simultaneously		

10.2) Checking the AL1 - CO₂ TWA parameter: Not user configurable.

1. Press Mode until the “AL1” & “CO ₂ ” icon flash			
2. Press Enter, the “AL1” icon shows on LCD. The CO ₂ TWA is fixed at 5000ppm			
3. Press Enter again or press Mode to quit the setting			

10.3) Setting the AL2 – 2nd CO2 Alarm Level parameter: User configurable. Must be unlocked, see Section 9.2.

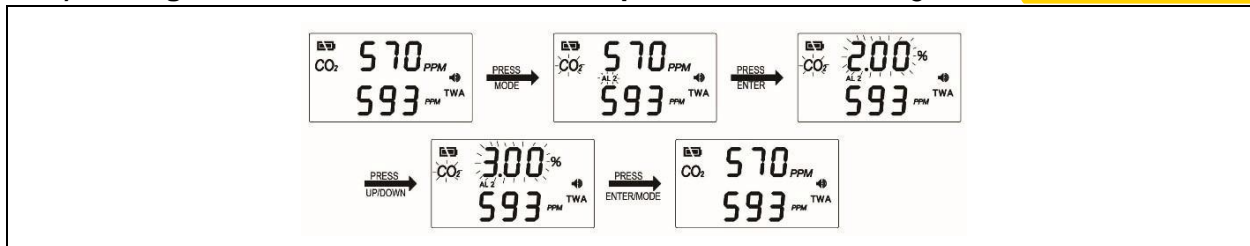

1. Press Mode until the “AL2” & “CO2” icons flash
2. Press Enter, the “AL2” icon shows on LCD, default AL2= 1.5%
3. Press Up/Down to go through “5000,1.0%,1.5%,2.0%,2.5%,3.0%” alarm level.
4. Press Enter again to save the setting after selection or press Mode to quit the setting

10.4) Setting the AL3 – 3rd CO2 Alarm Level parameter: User configurable. Must be unlocked, see Section 9.2.

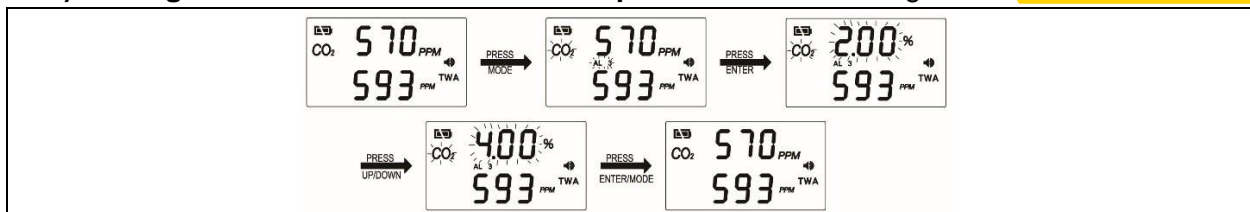

1. Press Mode until the “AL3” “CO2” icon flashes
2. Press Enter, the “AL3” icon shows on LCD. Default AL3=3.0%
3. Press Up/Down to go through “2.0%,2.5%,3.0%,3.5%,4.0%” alarm level
4. Press Enter again to save the setting after selection or press Mode to quit the setting

10.5) Calibration using the CO2 CALI function:

1. You will need a gas cylinder of pure Nitrogen (0 ppm CO2).
 2. Temporarily cover the buzzer hole on the bottom left-hand corner of the SEU (Main unit) and bottom right-hand corner on the RDU (remote display unit) with a small piece of masking tape to minimize the alarm sound during calibration.
 3. If calibration is to be performed installed, first inform building occupants that you will be testing the CO2 alarm for several minutes.
- ote: Please pump N2 (zero CO2) into the CO2 Sensor Entry (Item A in section 2) and wait about 3 minutes before calibration, then execute the “ZErO” calibration.

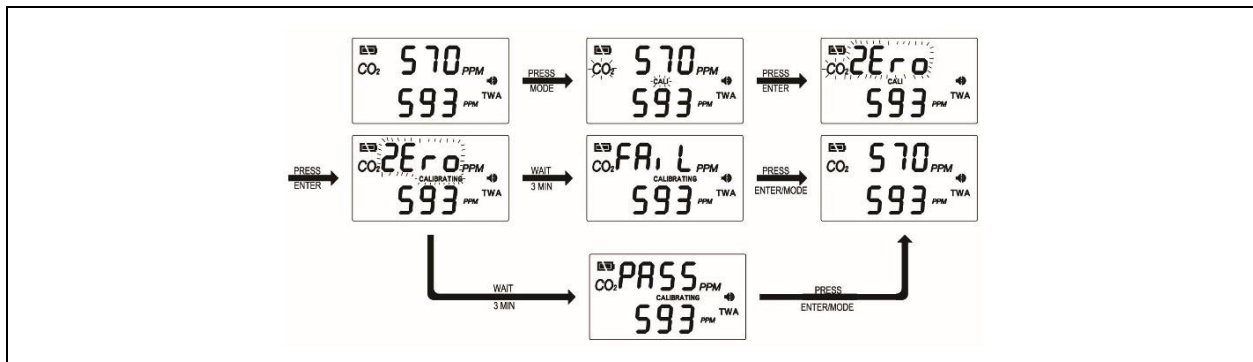

1. Hold the tubing from the Nitrogen (0ppm CO2) gas cylinder to the CO2 sensor opening (on the top left-hand corner).
2. Open the gas regulator. Flow rate should be between 0.15-0.50 liters per minute.
3. Wait until the CO2 reading on the SEU settles consistently at or near 0ppm CO2.
4. Press the Mode button 5 times, the “CO2” and “CALI” icon will start flashing on the SEU.
5. Press Enter to view the calibration settings. The SEU screen will now display a flashing “ZErO” and “CO2”.
6. Press Enter again to begin the calibration. “CALIBRATING” will begin flashing.
7. After approximately 3 minutes, the LCD will display either “PASS” or “FAIL”.
8. If the LCD reads “FAIL”, repeat the steps again. If it displays “PASS”, press Enter. The display should now show 0ppm.
9. Remove the nitrogen cylinder.
10. Reset the unit by either pressing the reset bottom (bottom right-hand corner with a round arrow) or power cycling the unit.
11. If your unit fails the “ZErO” calibration, please follow the procedure again before calling support.

10.6) Using the Recover factory setting function:

Note: If the user has set the customer parameters or calibrates the RAD-0102-6 incorrectly, please use the ReFactSet (recover the factory Setting) to recover the default factory setting

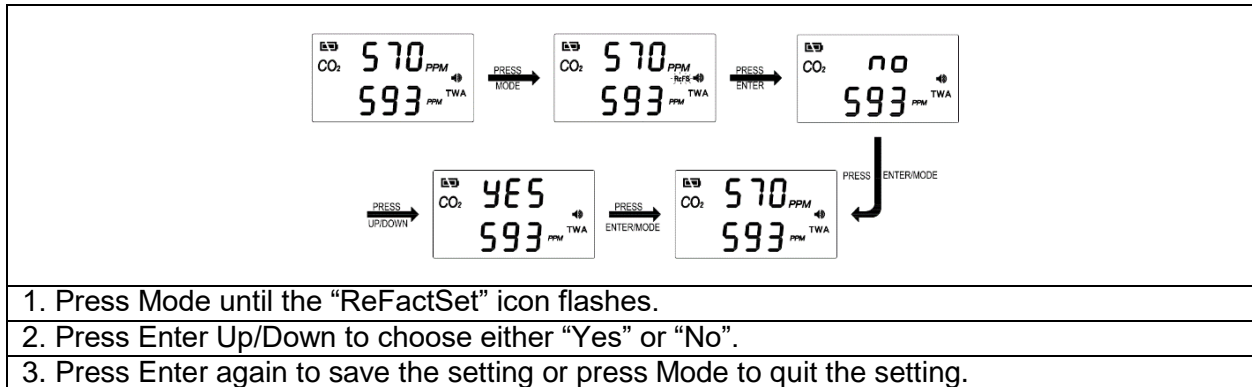

11. Safety Notice

Warning: Your safety is very important to us. To ensure the proper and safe use of the device, please read all warnings and the entire User Manual before using the device. Otherwise, the protection provided by the equipment may be impaired. These warnings provide important safety information and should be observed at all times.

1. Please handle the device carefully. Do not subject the product to impact or shock, as it could lead to sensor accuracy drift.
2. Do not place the unit near a heat source. Heat may distort the unit.
3. Do not touch the exposed electronic circuitry of the device under any circumstances, as there is danger of electric shocks. All relays are dry contact and are able to remain exposed without risk of electric shock.
4. Please take care of cable connection between SEU and RDU. Make sure the cable from SEU Output (RDU) port is connected to the RDU INPUT (SEU/RDU) port.
5. The dry contact relays do not provide power to external devices, like a ventilation fan. If there is no power supply to the fan, the relay will not work. This may result in potential danger with high CO2 concentration in confined space.
6. 6 bilingual Warning Signs are included with each device

12. Product Care

To ensure maximum benefit from this product, please observe the follow guidelines.

1. Repair - Do Not attempt to repair or modify the device in any way. Please contact CO2Meter directly if the product needs servicing, including replacement or calibration service. See Section 15 for technical support contact information.
2. Cleaning - Disconnect the power before cleaning. Use a damp cloth. Do not use liquid cleaning agents such as benzene, thinner or aerosols, as these will damage the device. Do Not splash the unit with water.
3. Maintenance – We recommend users to test the communication between the SEU and RDU using the ‘DIAG’ function to verify the working conditions of the SEU and RDU. If the five LEDs blink and the buzzer of SEU and RDU sound simultaneously, the SEU and RDU are working normally.

13. Specifications

■ CO2 & Temperature specification:

CO2 Specification	
Measurement Range	0 - 50,000ppm (5%) display
Display Resolution	10ppm at 0~10,000ppm; 100ppm at 10,001~50,000ppM
Accuracy	+/-200ppm or +/-10% reading
Pressure Dependence	Auto pressure compensation, built in barometer. (50 to 110 kPa)
Response Time	CO2: <2min by 90%
CO2 AL1 (TWA)	5000ppm fixed
CO2 AL2	5000, 1.0%, 1.5%, 2.0%, 2.5%, 3.0%. Default AL2= 1.5%.
CO2 AL3	2.0%,2.5%,3.0%,3.5%,4.0%. Default AL3= 3.0%
Sound Alarm	80db@10cm
Warm-Up Time	<60 seconds at 22°C
Temperature Specification:	
Temperature Range	0°C to 50°C (32°F to 122°F)
Display Resolution	0.1°C (0.1°F)
Display Options	°C/°F
Accuracy	±1.5°C(±2.7°F) when CO2 level is below first alarm level
Response Time	20-30 minutes (case must equalize with environment)
Operating Conditions:	
Temperature	0°C to 50°C (32°F to 122°F)
Humidity Range	0 ~ 95% RH non-condensing
Storage Conditions:	
Storage Temperature	-20°C to 60 °C (-4°F to 140°F)

■ Power Supply

Power Supply	DC	9~32VDC (12~32VDC recommended), 2A.
	AC adapter	Input: 100~240 VAC,50/60Hz, 0.6A Output: 12VDC, 2000mA.
Battery	Voltage	6VDC (5.4V~7.0V), recommended capacity is 12AH

■ Relay output

Relay 1	Operates at CO2 TWA
Relay 2	Operates at Alarm 2 level for CO2
Relay 3	Operates at Alarm 3 level for CO2

The Peak current for all relays is less than 2A@30 VDC or 250 VAC, SPDT.

■ 4-20mA Outputs

CL01:4-20mA	CO2: 0~50,000ppm
CL02:4-20mA	Temp: 32 to 122° F (0-50°C)

■ Weights and Dimensions

SEU	Weight	1 lb
	Dimensions (LxWxD)	6.69 x 4.96 x 2.73 inches
RDU	Weight	0.4 lb
	Dimensions (LxWxD)	5.51 x 3.54 x 1.89 inches

14. Fault Codes & Troubleshooting Guide

This section includes a list of Frequently Asked Questions for problems you may encounter with the RAD-0102-6 CO2 Monitor.

No	LCD Fault Icon	Description (of the fault)	SEU Indication	RDU Indication	Suggested Actions
1	Er3	Ambient temperature exceeded the temperature range 0°C to 50°C (32°F to 122°F)	“Er3” flash, Fault LED blink	“Er3” flash, Fault LED blink	This error will disappear when the temperature returns to the range between 0°C and 50°C (32°F to 122°F)
2	Er5	EEPROM System Problem	“Er5” flash, Fault LED blink	“Er5” flash, Fault LED blink	Power on again or press reset button, if the “Er5” always appear, please contact CO2Meter.
3	Er7	Internal Data Transmission Error	Flash, Fault LED blink,	Flash, Fault LED Blink	Check the RJ45 plug is connected into the INPUT port of RDU. Press reset button on SEU or power cycle the unit

15. Support & Warranty

Contact us: We're here to help!

If the troubleshooting guide above doesn't help you solving your problem or for more information, please contact us using the information below.



Support@CO2Meter.com
(386) 256-4910 (M-F 9:00am–5:00pm EST)

www.CO2Meter.com

See CO2Meter, Inc. Terms & Conditions at:

www.CO2Meter.com/pages/terms-conditions

CO2Meter, Inc.

131 Business Center Drive
Ormond Beach, FL 32174
Phone: 386-872-7665 | Fax: 866-422-2356
Email: Sales@CO2Meter.com



Ref. No.:062017